



Passionate about Music
It's what we do!

Better Music Builder®.com

Better Music Builder® is a leader in the Audio and Karaoke equipment industry. We are committed to offering you high quality audio products. Unlike any others brand, we deliver the best cost and value to you directly. For the latest update information including operation manuals, installation instructions, hook-up diagram and other new technologies updates etc. please visit us at our website www.BetterMusicBuilder.com.

OWNER'S MANUAL

PROFESSIONAL MIXING AMPLIFIER

DX-211 G2

G2 SERIES
Generation 2

















Thank you for purchasing this unit. To make full and effective use of this unit, please read this Owner's Manual carefully before operating it. Please retain this manual for future reference.

www.BetterMusicBuilder.com



CONTENTS

	INTRODUCTION.....	3
	SYSTEM FEATURES.....	3
	SAFETY INSTRUCTIONS.....	4~6
	PACKAGE ACCESSORIES.....	6
	SPEAKER CONNECTION METHODS AND INFORMATION.....	7
	SYSTEM APPLICATIONS.....	8
	• Line Pre-out Extension for Large Format Sound System.....	8
	• 4-Channel Mixing Amplifier for Commercial Use.....	9
	• Connecting the Main Speakers.....	10
	• Connecting the Audio Line Pre-out.....	10
	• Connecting the Audio Input Source.....	11
	• Connecting the Subwoofer.....	11
	• Connecting the Microphone Input.....	12
	CONTROLS AND FUNCTIONS.....	13
	• Front Panel.....	13
	• Rear Panel.....	14
	• Remote Control.....	15
	OPERATION.....	16
	PHYSICAL DIMENSIONS.....	17
	SPECIFICATIONS.....	17
	TROUBLESHOOTING.....	18~19
	WARRANTY.....	20
	AGENCY REGULATORY NOTICES.....	21
	FINAL WORDS TO USER.....	22
	CONTACT INFORMATION.....	23



INTRODUCTION

The DX-211 G2 is the newest in our DX Series Karaoke amplifiers. With commercial like functions this new amplifier is bringing KTV right to your living room!

Equipped with a 4-pin S-Video plug, the DX-211 G2 is compatible with Karaoke Remote control (sold separately), perfect for use without reaching the amplifier itself. By storing the amplifier in a well ventilated area (e.g. systems room with air ventilation) the amplifier can work at full potential in an appropriate environment, and with the Karaoke Remote compatibility you won't need to run back and forth adjusting the mixer since it can be controlled by remote.

Like the first generation, DX-211 G2 has the "SAIS" (Smart Audio Input Select) function that selects the active input over inactive audio inputs, so it will always tune to the playing music!

What is SAIS?

Smart Audio Input Select is the ability to set a priority audio source when audio is playing, and reverting back to the previous input when inactive.

BGM (Background Music) is set to play full time, until a priority source starts playing. In the priority are DVD and VOD, when either is active BGM will no longer be the playing source. When both DVD and VOD are inactive, source will automatically change to Background Music.

DX-211 G2 Front View

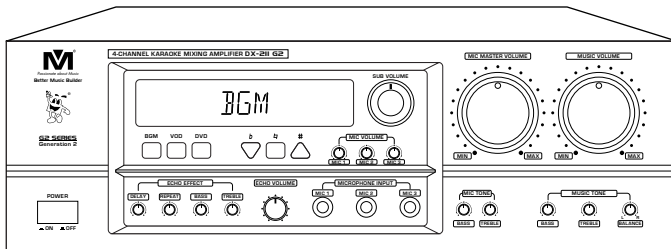

DX-211 G2 Rear View

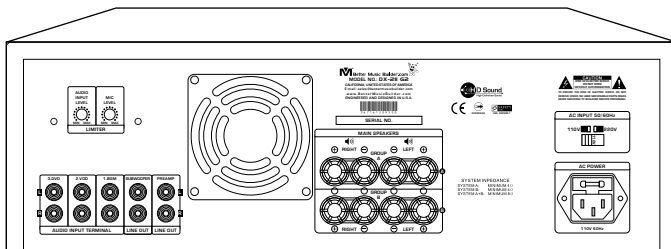

SYSTEM FEATURES

4-CHANNEL KARAOKE MIXING AMPLIFIER

- 4-Channel Mixing Amplifier
- 3 Band Microphone Equalizer
- Microphone Exciter
- 2 Band Music Equalizer (Bass, Treble) +/- 12dB adjustment for mid and bass and +/- 10dB adjustment for treble.
- Music Balance: Balances audio output of the speakers from left to right
- Microphone Echo Effect controls: Delay, Repeat, Bass and Treble
- 9-Steps Key Control
- Individualized volume control for for subwoofer, echo, microphone and music
- Available to adjust frequency 80Hz~250Hz of SUB channel.
- PC remote control capability
- Smart Audio Input Select (SAIS): priority selection of audio inputs.
- Audio input sensitivity (for AUTO input setting).
- Microphone input sensitivity.
- Inputs: 3 microphone inputs and 3 audio inputs
- Outputs: 1 audio output
- LED indicator for signal output.
- Music "Mute" allows the microphone to be active while the music is off.
- Smart fan

DX-211 G2 PACKAGE CONTENTS:

- Amplifier: 1 pc
- Remote Control: 1 pc
- Power Cable: 1 pc
- Instructional Manual: 1 pc
- Warranty & Registration Card: 1 pc



SAFETY INSTRUCTIONS

Please visit our website at BetterMusicBuilder.com for the most updated information, corrections on errors and changes in this manual. You may also contact us at toll free at 1-800-318-2218.



1. Read Instructions: All the safety and operation instructions should be read before this product is operated.
2. Retain Instructions: The safety and operating instructions should be kept for future reference.
3. Warnings: All warnings on this product in these operating instructions should be followed.
4. Follow Instructions: All operating and other instructions should be followed carefully.
5. Water and Moisture: This product should not be used near water, for example, near a bathtub, washbowl, kitchen sink, laundry tub, in a wet basement, near a swimming pool, swamp or salivating St. Bernard dog, etc.
6. Cleaning: Clean only with a dry cloth.
7. Ventilation: This product should be situated so that its location or position does not interfere with its proper ventilation. For example, the Component should not be placed on a bed, sofa, rug, or similar surface that may block any ventilation openings, or placed in a built-in installation such as a bookcase or cabinet that may impede the flow of air through ventilation openings.
8. Heat: This product should be stayed away from heat sources such as radiators, or other devices producing heat.
9. Power Sources: This product should be connected to a power supply only of the type described in these operation instructions or as marked on this product.
10. Power Cord Protection: Power supply cords should be routed so that they are not likely to be walked upon or pinched by items placed upon or against them. Please pay particular attention to cords plugs, convenience receptacles, and the point where they exit this product.
11. Object and Liquid Entry: Care should be taken so that objects do not fall on, or liquids are not spilled into this product.
12. Damage Requiring Service: This product should be serviced only by qualified service personnel when:

- A. The power-supply cord or the plug has been damaged; or
- B. Objects have fallen, or liquid has spilled into this product; or
- C. This product has been exposed to rain; or
- D. This product does not appear to operate normally or exhibits a marked change in performance; or
- E. This product has been dropped, or its chassis has been damaged.

13. Servicing: The user should not attempt to service this product beyond those means described in this operating manual. All other servicing should be referred to the Service Department.

14. To prevent electric shock, do not use this polarized plug with an extension cord, receptacle or other outlet unless the blades can be fully inserted to prevent blade exposure.

15. Grounding or Polarization: Precautions should be taken so that the grounding or polarization means of this product is not defeated.

16. Power Precaution: Unplug this product during lightning storms or when unused for long periods of time. Note that this product is not completely disconnected from the AC power source when the power switch is in the OFF position.

17. This machine does not exceed the Class A/Class B (whichever is applicable) limits for radio noise emissions from digital apparatus as set out in the radio interference regulations of the US Department of Communications.

AC-POWER SOURCES

This set should be operated only from the type of power source indicated on the marking label. If you are not sure of the type of electrical power supplied to your home, consult your dealer or local power company. For those sets designed to operate from battery power, or other sources, refer to the operating instructions.

This unit is designed for use with 120V/60Hz AC. If the area where you live have different power source, you may need to use a transformer to convert to 120 Volts AC.

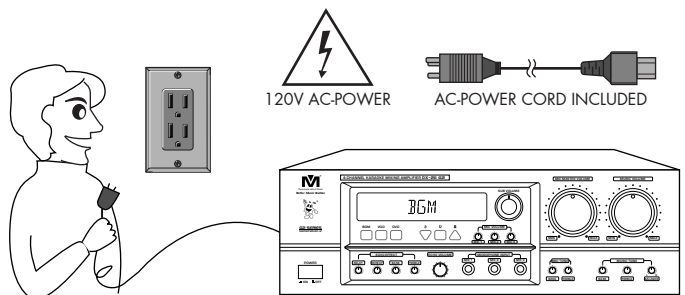

OVERLOADING

Do not overload wall outlets, extension cords or convenience receptacles beyond their capacity, since this can result in fire or electric shock.

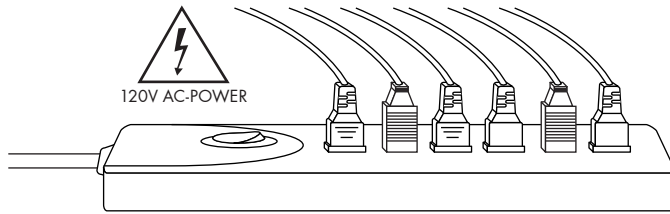

An appliance and cart combination should be moved with care. Quick stops, excessive force and uneven surfaces may cause the appliance and cart combination to overturn.

Do not place the electronic equipment onto the unstable table or stand.

It is because it would fall easily from the unstable table or stand, so it may cause accident including personal injuries and damage the equipment. Please follow our instructions to install the equipment, or you may hire a professional technician to handle the installation for safety purpose.

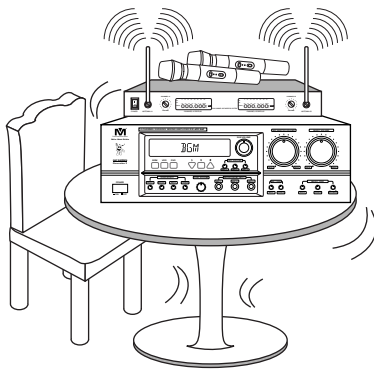

Do not place the set on an unstable cart, stand, tripod, bracket, or table. The set may fall, causing serious injury to a child or an adult and serious damage to the set. Use only a cart stand tripod, bracket, or table recommended by the manufacturer.

For the set with a three-wire grounding type ac plug:

This plug will only fit into a grounding-type power outlet. This is a safety feature. If you are unable to insert the plug into the outlet, contact your electrician to have a suitable outlet installed. Do not defeat the safety purpose of the grounding plug.

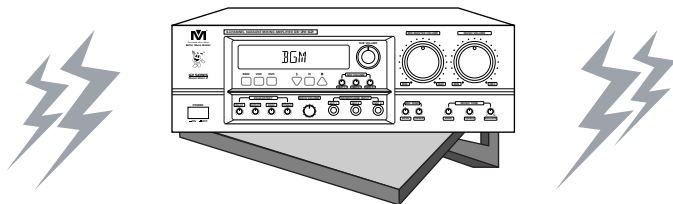

Do not store the electronic equipment near water or area with moisture such as bathroom, kitchen sink, laundry area and swimming pool, etc.

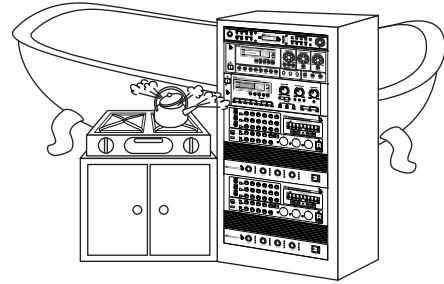

Do not transport the electronic equipment by yourself if its weight exceeds 70 pounds.

It is recommended that two people work together to transport the equipment or by using hand truck and the like.

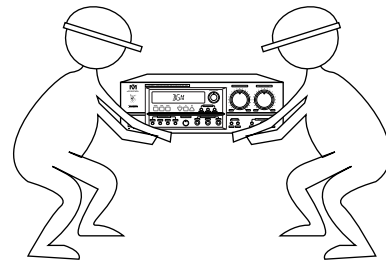

Do not place the electronic equipment directly under sunlight or close to the window.

It may cause overheat on the electronic equipment by the sunlight.

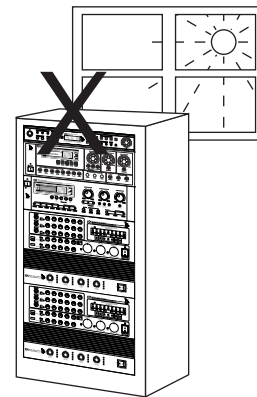

Do not block the openings and vents in the cabinet which is designed for the ventilation of the electronic equipment.

The blocking may cause overheat in the electronic equipment because of insufficient circulation of air, so it would damage the electronic equipment.

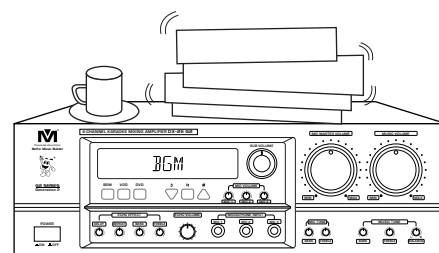

Do not place the electronic equipment near heat sources such as stoves, radiators and heaters, etc. Placing the electronic equipment too near to these heat sources would result in damaging the equipment and causing fire.

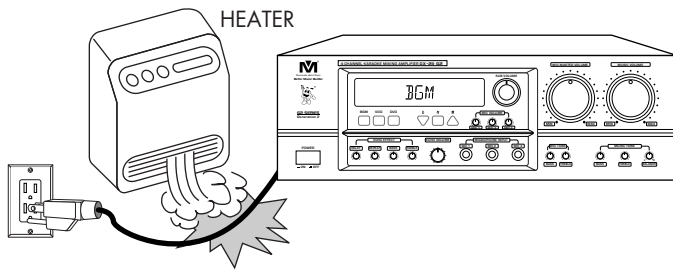

Using the Remote Control Unit

Use the remote control unit by pointing it towards the remote control sensor on the amplifier. Objects between the remote control unit and the remote control sensor may prevent proper operation.

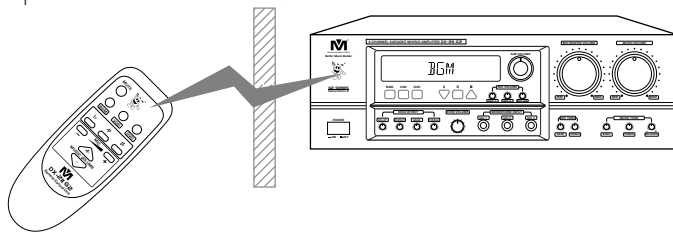

Cautions Regarding the Remote Control Unit

- Do not expose the remote control unit to shock. In addition, do not expose the remote control unit to liquids, and do not place in an area with high humidity.

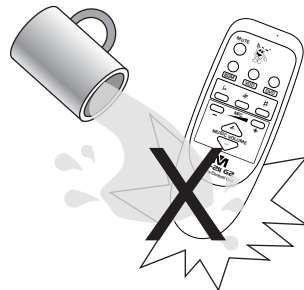

- Do not install or place the remote control unit under direct sunlight. The heat may cause deformation of the remote control unit.
- The remote control unit may not work properly if the remote control sensor on the amplifier is under direct sunlight or strong lighting. In such cases, change the angle of the lighting or the amplifier, or operate the remote control unit closer to the remote control sensor.

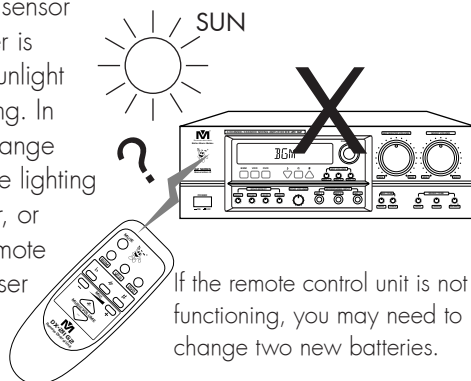

If the remote control unit is not functioning, you may need to change two new batteries.



PACKAGE ACCESSORIES

The package comes with (1) amplifier, (1) owner's manual, (1) warranty & registration card, (1) remote control, (2) AAA size batteries, and (1) AC power cable. All other accessories mentioned in the manual for installation purpose are not included. They are sold separately.

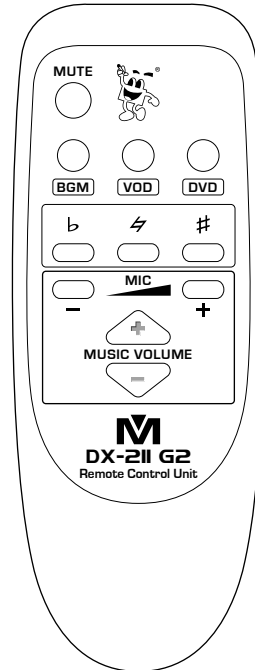

Remote control

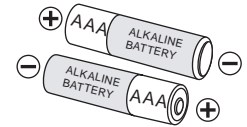

Battery size: AAA (R6 1.5 V)



AC power cable (6 feet)
United States (2M) to IEC (F)



Consumer warranty and registration card
<Mail in U.S.A. only> Consumers from Canada can get the warranty card by downloading it from our website www.BetterMusicBuilder.com.

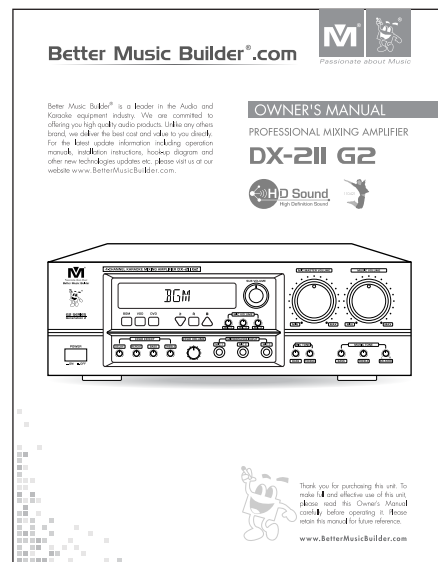

Owner's Manual



SPEAKER CONNECTION METHODS AND INFORMATION

CONNECTOR INFORMATION

Balanced XLR Connectors

	XLR	TRS
Hot (+)	Pin 2	Tip
Cold (-)	Pin 3	Ring
Shield (Ground)	Pin 1	Shield

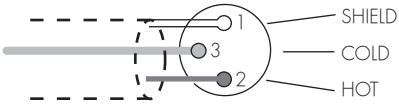

XLR to 1/4" Cable

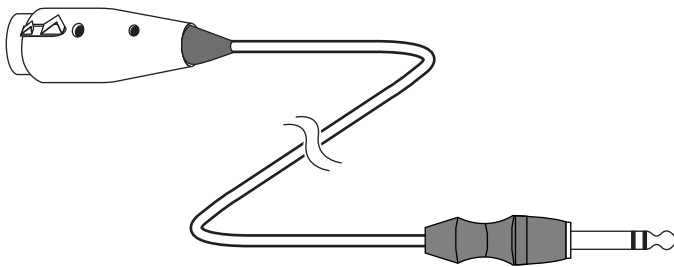

XLR to RCA Cable

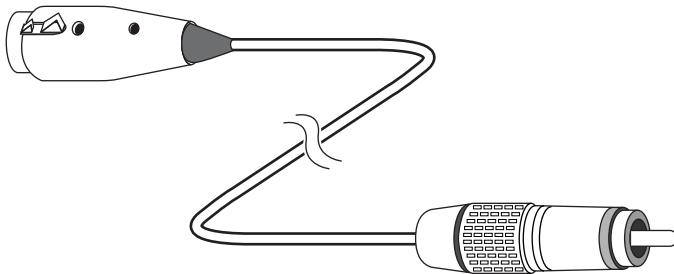

1/4" to 1/4" Cable

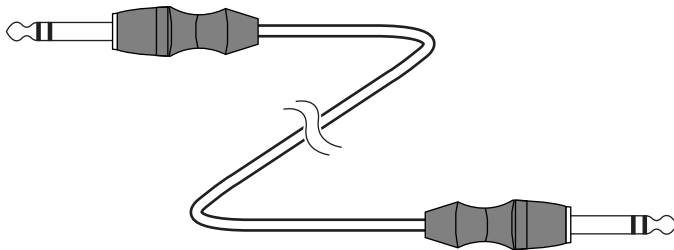

METHODS OF SPEAKER CONNECTION

1. Wire Insert Type (Poor Connection)

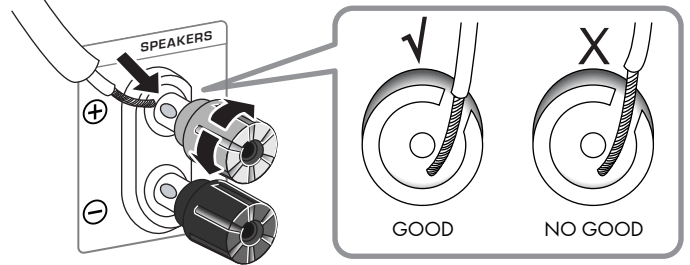

2. Double Banana Plug Type (Standard Connection)

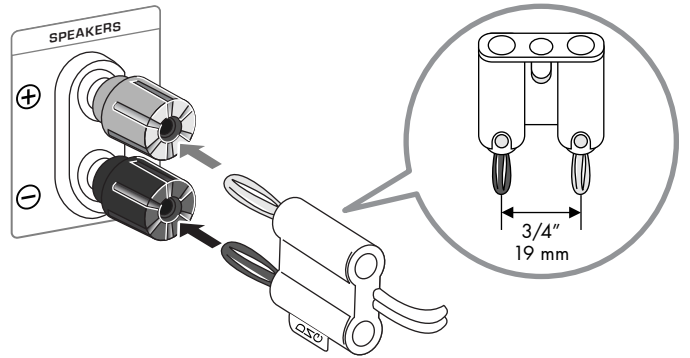

3. Single Banana Plug Type (Superior Connection)

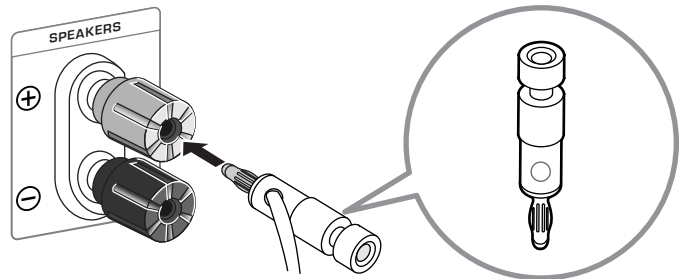

Either banana plug or wire insert type can be used to connect the unit to speakers. Be sure to connect red (+) to red (+) and black (-) to black (-). Otherwise, the sound output would be 180° out of phase and distorted.

Follow these steps to insert the wire directly into the speaker terminal.

1. Strip off the vinyl covering and twist the tip of the wire core.
2. Loosen the knob and insert the wire core into the terminal hole.
3. Tighten the knob to fix the wire core in place.

Do not allow the wire core to protrude or touch other terminals or wires, otherwise, damage may occur.



SYSTEM APPLICATIONS

LINE PRE-OUT EXTENSION FOR LARGE FORMAT SOUND SYSTEM

DX-211 G2 is an excellent professional amplifier with power output of 260 watts. It's perfect for karaoke and DJ. Using the line pre-out output offered by the DX-211 G2, you can extend its functions by connecting to other devices to get the full live sound effect.

DX-211 G2 REAR VIEW

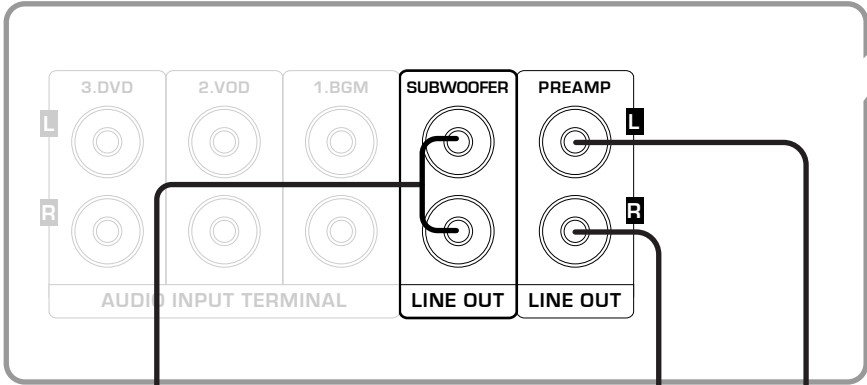
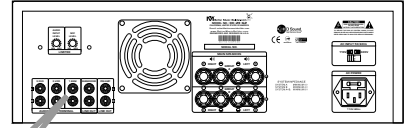

Why connect an additional 3-channel power amplifier to a mixing amplifier?

The DX-211 G2's power can only reach a maximum of 800 square feet, if it's being used in a bigger area like a commercial space, you'll need to extend its power by connecting to a 2-channel power amplifier. 3-channel power amplifier is also available. Please review the diagram. We recommend contacting our authorized dealer for advice and recommendation on connections.

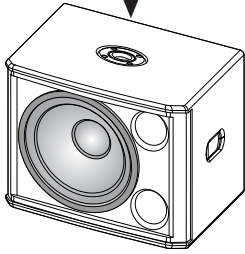

BASS/SUBWOOFER
NON-POWERED UNIT
15" DFS-115 SUB 2.1

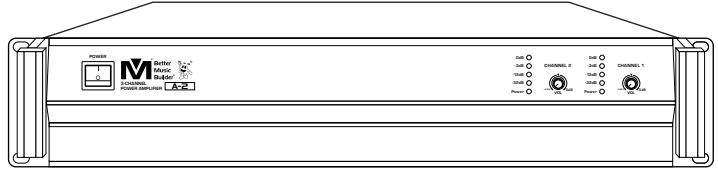

2-CHANNEL POWER AMPLIFIER

Connect to 2-Channel Power Amplifier for more power

CHANNEL 1: MAIN RIGHT SPEAKER
CHANNEL 2: MAIN LEFT SPEAKER

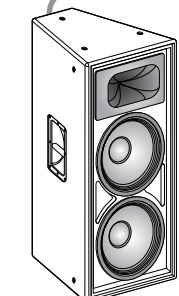

MAIN LEFT
NON-POWERED UNIT
15" SPEAKER

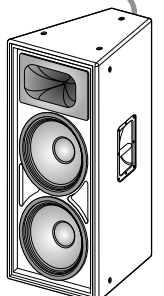

MAIN RIGHT
NON-POWERED UNIT
15" SPEAKER

LARGE FORMAT
SOUND SYSTEM

4-CHANNEL MIXING AMPLIFIER FOR COMMERCIAL USE

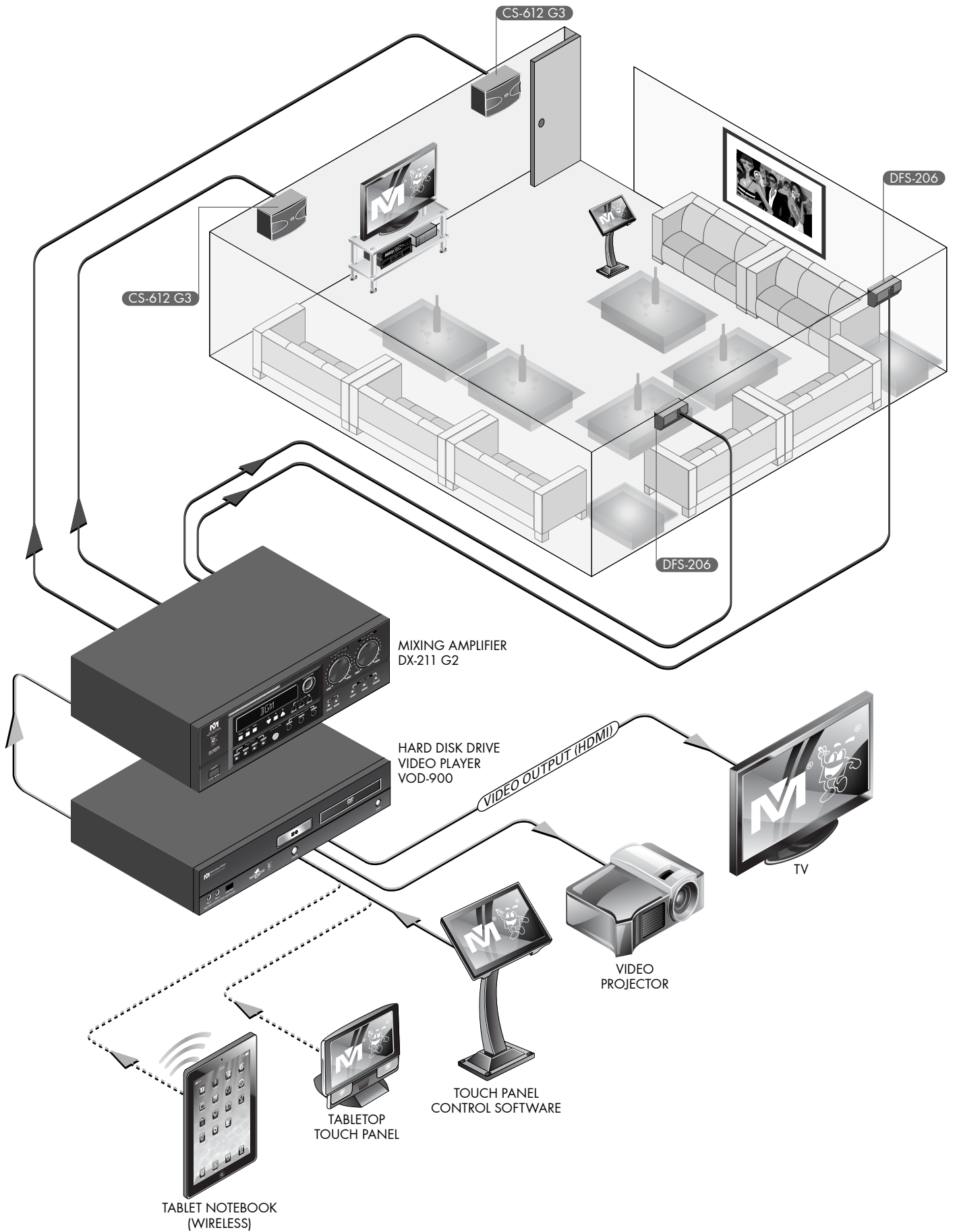

CONNECTING THE MAIN SPEAKERS

DX-211 G2 is capable of driving four main speakers, which are grouped in Group A and Group B. We recommend using different size speakers for Group A (10-inch woofer or bigger) and Group B (6-inch woofer). Under this arrangement, Group A speaker can produce greater bass music output while Group B speaker can produce clear vocal. The mixing

of music and vocal is important to produce quality sound for singing. Therefore, the audience can feel different effects from Group A and Group B speakers. You can also adjust the vocal on both speakers, or you can adjust the vocal in either speaker by adjusting the balance.

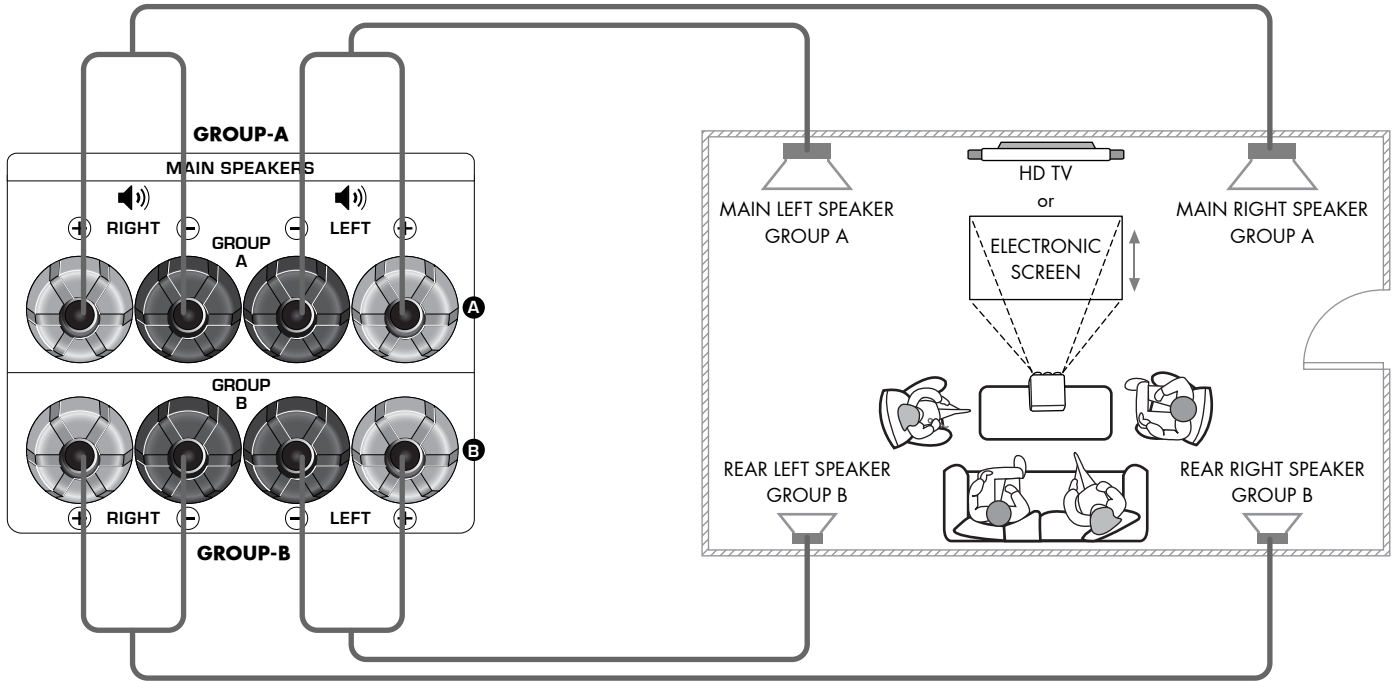

CONNECTING THE AUDIO LINE PRE-OUT

DX-211 G2 REAR VIEW

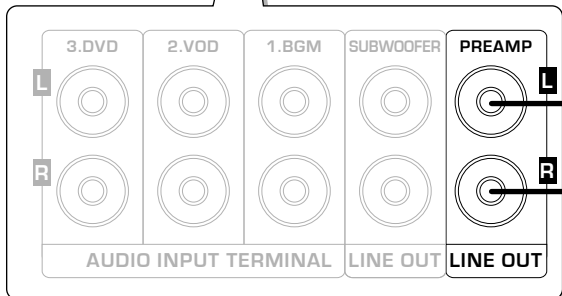
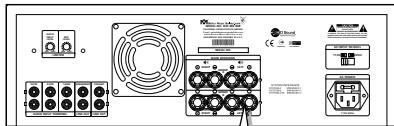

The 1/4" unbalanced cable is a standard audio signal connection. The XLR balanced cable is a higher quality signal connection recommended for the best audio performance.



AUDIO (XLR) BALANCE OUTPUT
RCA TO XLR (MALE) CABLE

POWER AMP REAR VIEW

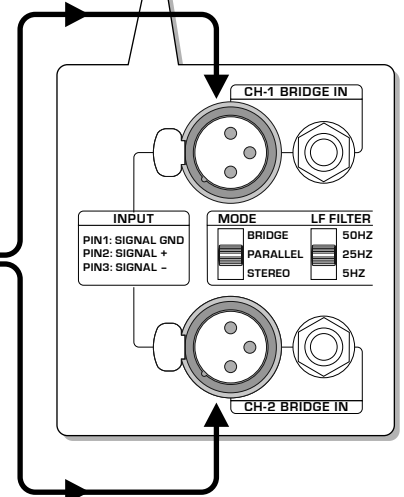
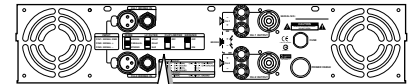

CONNECTING THE AUDIO INPUT SOURCE

Before connecting the source (i.e. BGM [1], VOD [2], DVD [3]), turn off power for all devices to prevent damage to the equipment. To connect the audio source, please refer to the diagram. To ensure high quality sound and video, we recommend using high quality cables and connectors.

VOD stands for Video On Demand. It is a karaoke player with built-in hard drive capable of storing a large amount of music videos. VOD is an all inclusive software and hardware

management tools controlled by a computer. VOD is capable of handling all the accounting management includes food/beverage, hourly room rentals, content and distribution of music videos on an as needed basis. This is the main workhorse of the KTV commercial business.

NOTE If there's a humming sound after turning on the machine, the audio connection may be in the video input or the video connection may be in the audio input.

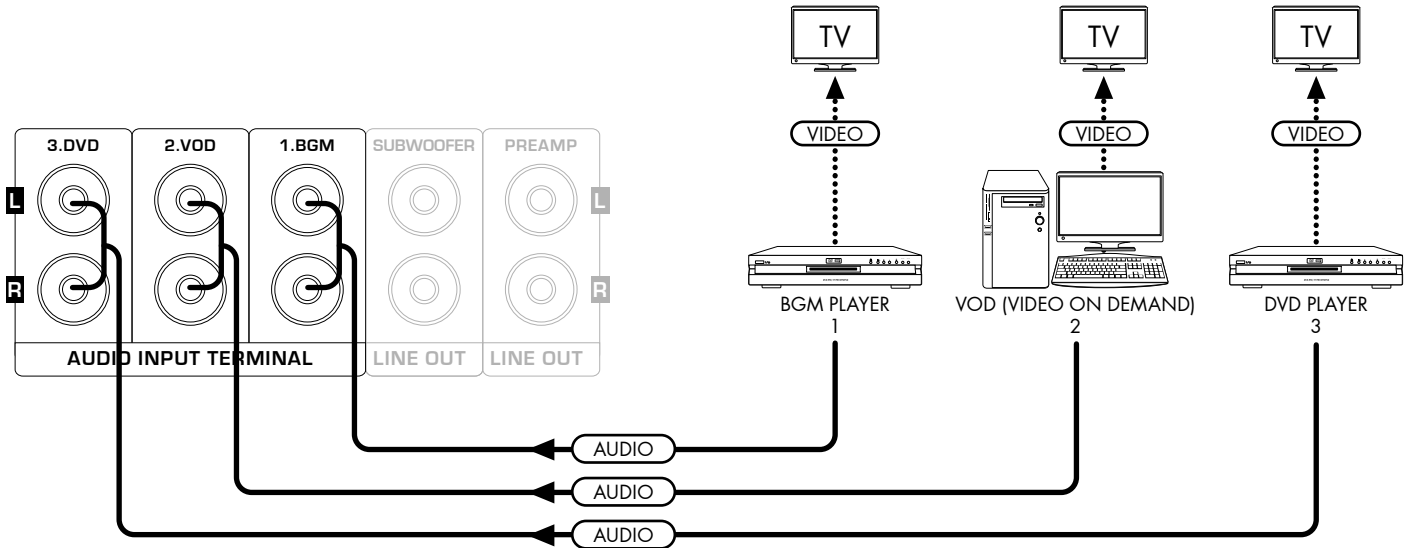

CONNECTING THE SUBWOOFER

When connecting a subwoofer to the SUBWOOFER LINE OUT, be sure to use Active/Powered subwoofer.

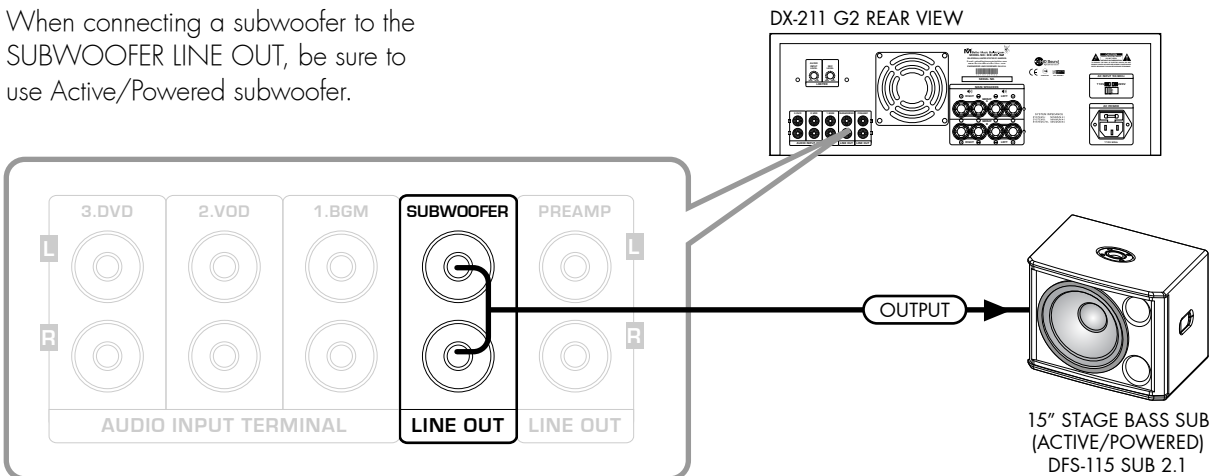

CONNECTING THE MICROPHONE INPUT

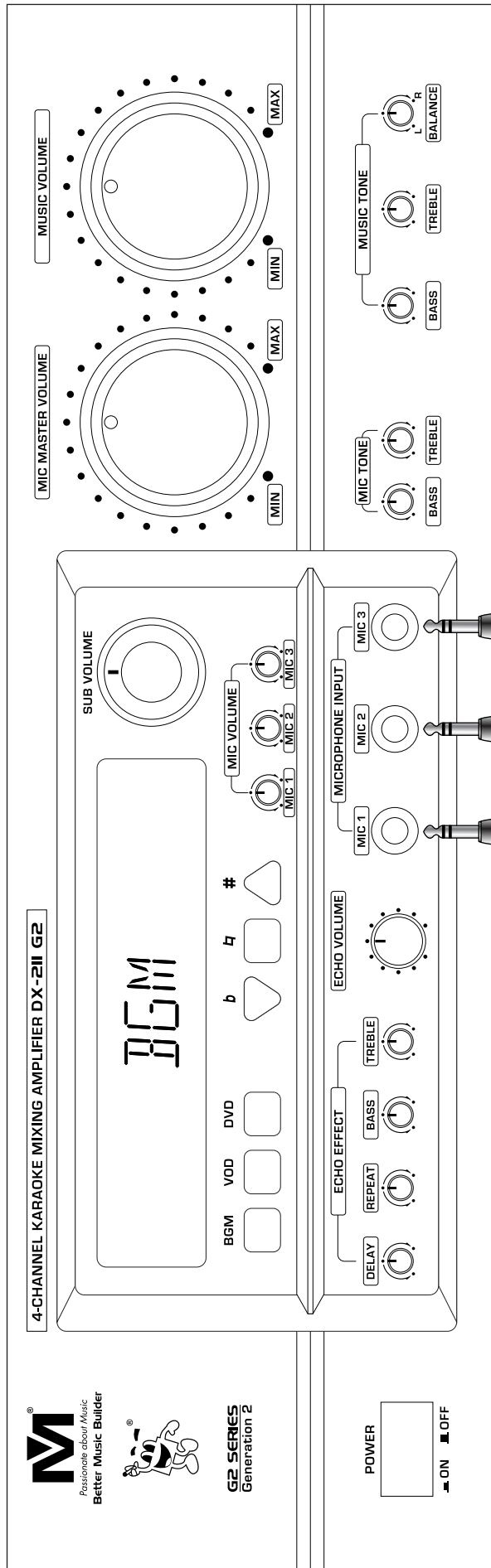

INPUT SELECT: BGM, VOD, DVD, AUX

In the front panel only three buttons are selectable; BGM, VOD, and DVD.

To select the auxiliary (AUX), press the "BGM" button twice for priority search, then the DX211 G2 will automatically select AUX input.

This function will select priority four inputs in the back, from top priority to least in the following order: BGM, VOD, DVD, AUX

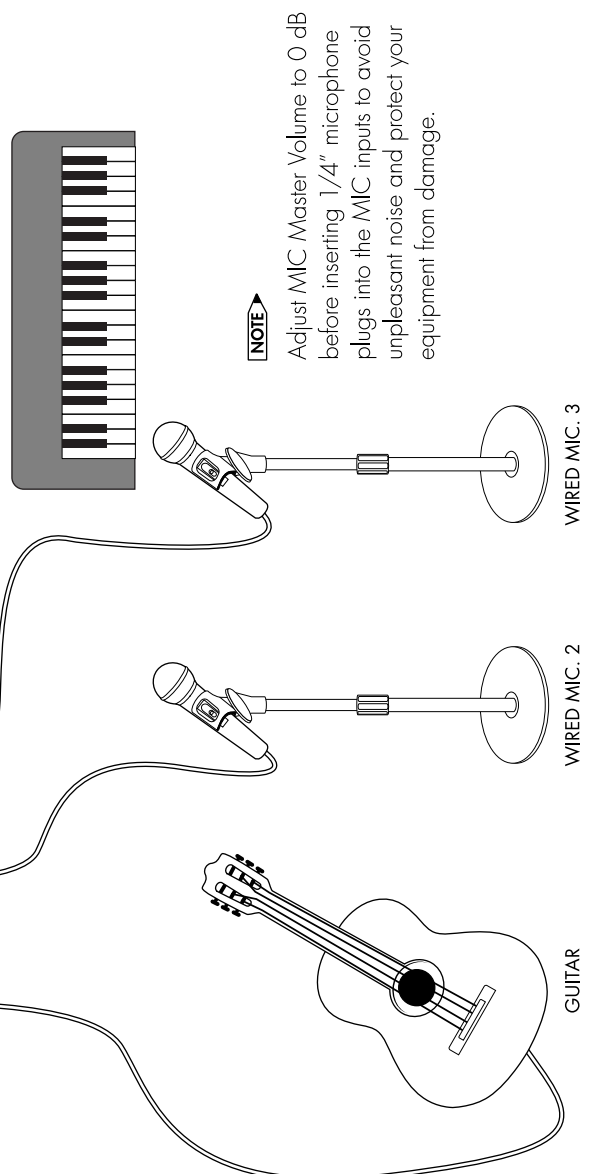



CONTROLS AND FUNCTIONS

FRONT PANEL:

1 INPUT MODE SELECTION: BGM, VOD, DVD

Press this button to manual select the input source.

To select the auxiliary (AUX), press the "BGM" button twice for priority search, then the DX-211 G2 will automatically select AUX input.

2 MUSIC KEY CONTROL BUTTON:

♭ **LOW**, ♮ **NATURAL**, # **HIGH** - Controls the music key.

3 LCD: System status display.

4 MICROPHONE VOLUME

Controls the amount of overdrive or "distortion." It increases the internal amplification of the microphone.

5 SUBWOOFER VOLUME

Controls subwoofer volume.

6 MIC MASTER VOLUME

Controls microphone volume.

7 MUSIC VOLUME

Controls music volume.

8 POWER BUTTON ON/OFF

9 ECHO EFFECT: This is the echo control for the microphone effects.

DELAY: Turning the knob to increase and decrease the echo delay time coming from the microphone.

REPEAT: Turning the knob to increase and decrease the repeat time coming from the microphone.

BASS: Turning the knob to increase and decrease the bass low tones coming from the microphone.

TREBLE: Turning the knob to increase and decrease the high tones coming from the microphone.

10 ECHO VOLUME

Controls the echo volume for microphone effects.

11 MICROPHONE INPUTS (1/4 inch SLOT)

12 MIC TONE

BASS: Controls lower voice tones.

TREBLE: Controls higher voice tones.

13 MUSIC TONE

BASS: Controls music low tones.

TREBLE: Controls music high tones.

14 MUSIC BALANCE

Adjusts the music signal for left and right speakers.

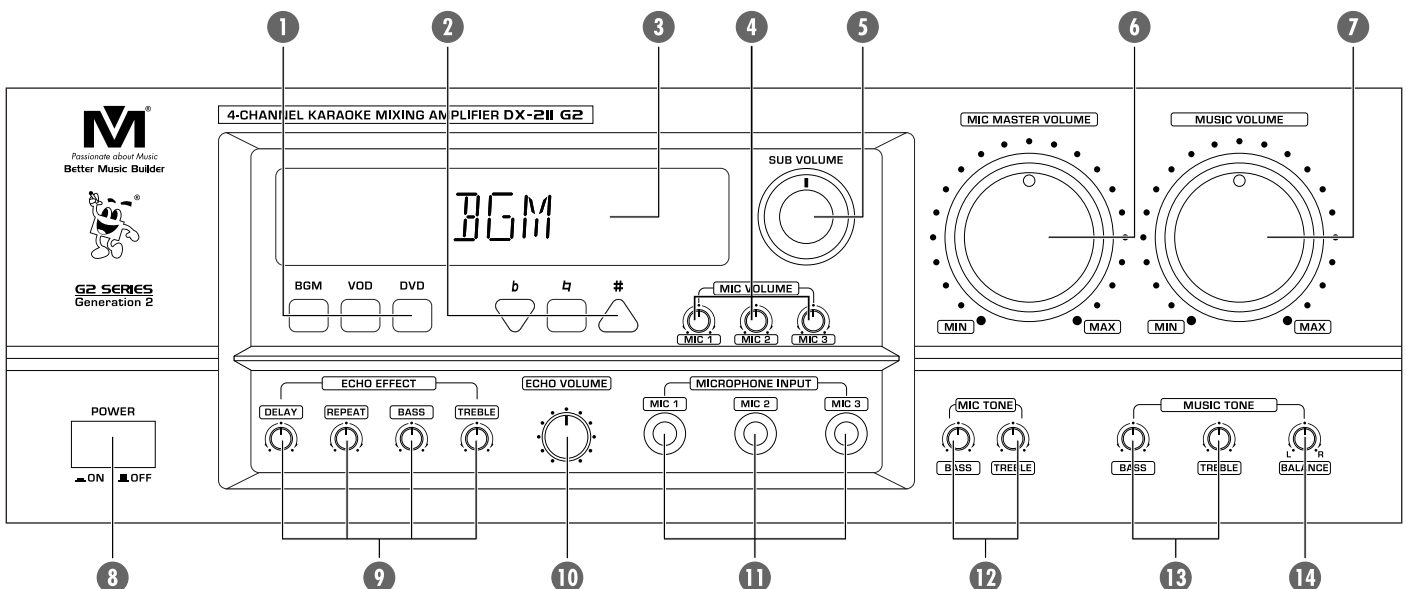

REAR PANEL:

- 15 **AUDIO INPUT LEVEL:** Controls the audio signal sensitivity. It acts as a volume limiter.
- 16 **MIC INPUT LEVEL:** Controls microphone signal sensitivity. It acts as a volume limiter.
- 17 **AUDIO INPUT TERMINAL:** 4 audio input sources: BGM [1:priority source], VOD [2], DVD [3].
- 18 **SUBWOOFER LINE OUT:** Dedicated line output for a subwoofer.
- 19 **LINE PRE-OUTPUT**
- 20 **LOW NOISE DUAL UNITS COOLING FAN**
- 21 **MAIN LEFT SPEAKER OUTPUT TERMINAL:** Dedicated Group-A & Group-B main left channel powered output.
- 22 **MAIN RIGHT SPEAKER OUTPUT TERMINAL:** Dedicated Group-A & Group-B main right channel powered output.
- 23 **AC-POWER:** 110V for USA & Canada. 220V for Asia and Europe authorized dealer for details.
- 24 **FUSE:** Housing for the power supply fuse.
- 25 **VOLTAGE SELECTOR**
Grid voltage corresponding switch.

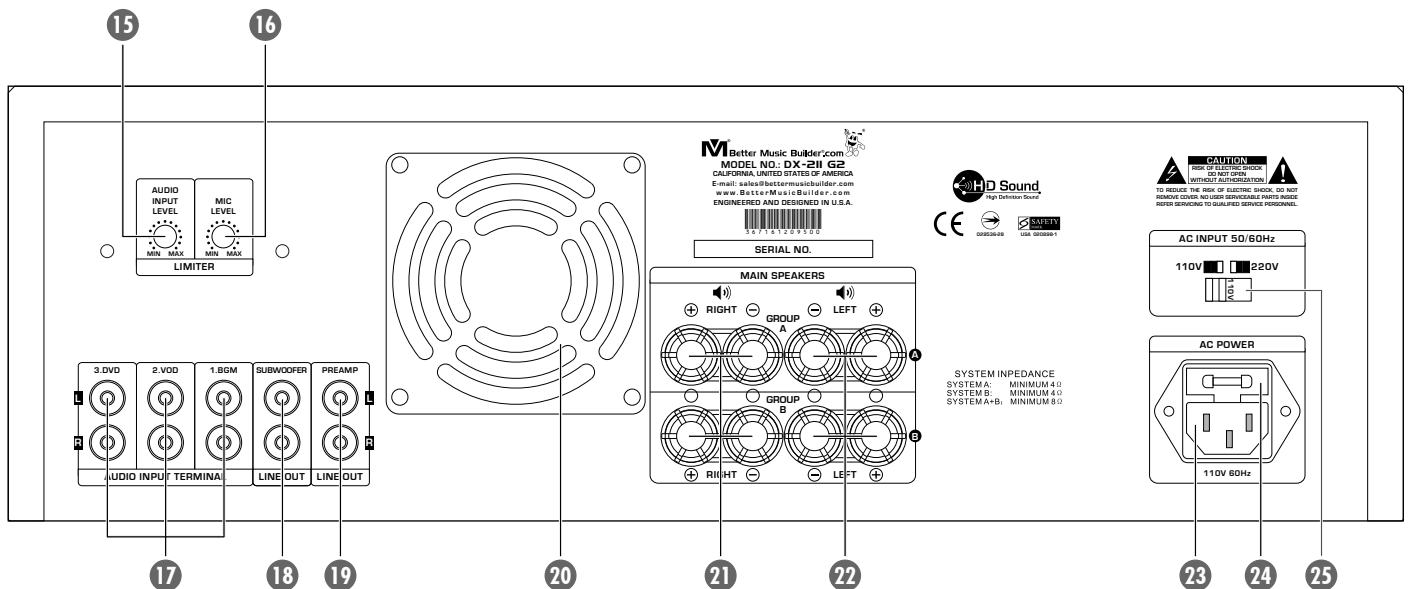

REMOTE CONTROL:

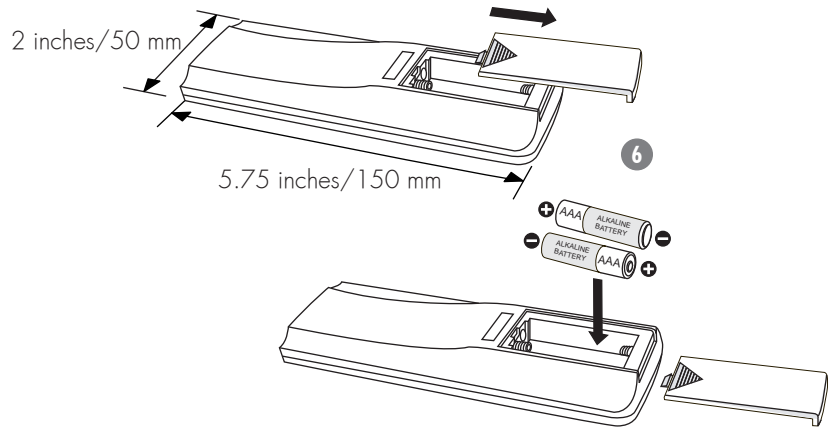
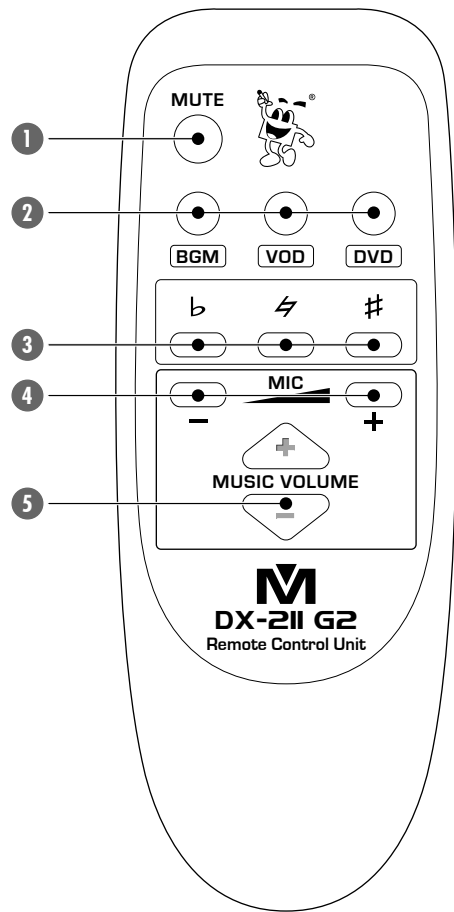

6 INSERTING BATTERIES

Open the battery compartment cover on the back of the remote control unit. The cover should open easily if you press and slide it in the direction of the arrow. Insert two AAA batteries as shown and slide the cover back on.

7 USING THE REMOTE CONTROL UNIT

When operating the remote control, point the remote's infrared port on the front panel. The remote control can be used within a range of 18 feet (6 meters) from the remote sensor, and within angles of up to 30 degrees.

1 MUTE

Mutes music only; does not mute vocal.

2 INPUT SELECTION: BGM, VOD, DVD

Press this button to select the input source.

3 KEY CONTROL: b LOW, ♮ NATURAL, # HIGH

Controls the music key.

4 MICROPHONE MASTER VOLUME

Microphone Master Volume control.

5 MUSIC MASTER VOLUME

Music Master Volume control.

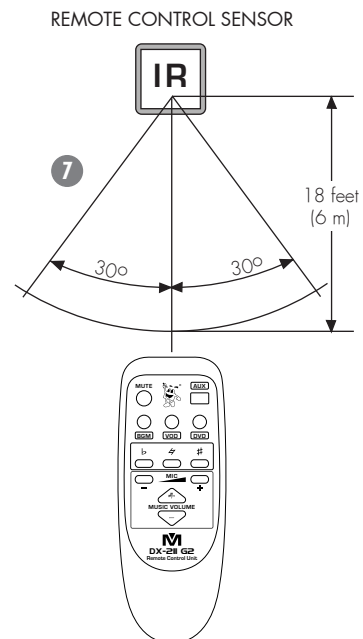



OPERATION

FRONT PANEL OPERATION

MICROPHONE INPUT



There are three microphone inputs (1/4" slot) on the front panel.

ADJUSTING THE MICROPHONE VOLUME



There are three knobs under MICROPHONE VOLUME: MIC 1, MIC 2, MIC 3

MIC 1: This knob controls the volume for microphone 1.

MIC 2: This knob controls the volume for microphone 2.

MIC 3: This knob controls the volume for microphone 3.

ADJUSTING THE ECHO EFFECT

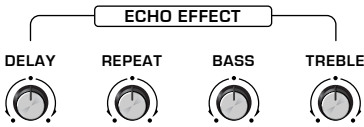

There are four knobs under the ECHO EFFECT: DELAY, REPEAT, BASS and TREBLE.

DELAY: Turning the knob to adjust the echo delay time coming from the microphone.

REPEAT: Turning the knob to adjust the repeat time coming from the microphone.

BASS: Turning the knob to adjust the bass low tones coming from the microphone.

TREBLE: Turning the knob to adjust the high tones coming from the microphone.

ADJUSTING THE SUBWOOFER VOLUME



This knob controls the volume for SUBWOOFER. Turn the knob clockwise to increase and counter-clockwise to decrease the subwoofer volume.

ADJUSTING THE MUSIC TONE



There are three knobs under the MUSIC TONE: BASS, TREBLE and BALANCE.

BASS: Turn the knob clockwise to increase and counter-clockwise to decrease the bass output.

TREBLE: Turn the knob clockwise to increase and counter-clockwise to decrease the treble output.

BALANCE: Adjusts the music output for left and right speakers.

ADJUSTING THE MICROPHONE TONE



There are two knobs under the MICROPHONE TONE: BASS and TREBLE.

BASS: Turn the knob clockwise to increase and counter-clockwise to decrease the lower voice tones.

TREBLE: Turn the knob clockwise to increase and counter-clockwise to decrease the higher voice tones.

ADJUSTING THE MUSIC VOLUME



This knob controls the volume for MUSIC. Turn the knob clockwise to increase and counter-clockwise to decrease the music volume.

ADJUSTING THE MIC MASTER VOLUME



This knob controls the volume for MICROPHONE. Turn the knob clockwise to increase and counter-clockwise to decrease the microphone volume.

ADJUSTING THE ECHO VOLUME



This knob controls the volume for ECHO. Turn the knob clockwise to increase and counter-clockwise to decrease the echo volume.



PHYSICAL DIMENSIONS

NET WEIGHT	23.8 lbs / 10.8 Kg
SHIPPING WEIGHT	26 lbs / 11.8 Kg
DIMENSIONS (WxHxD)	17x5.3x14.1 in / 43x13.5x35.8 cm
PACKING DIMENSIONS (WxHxD)	20x8x18.5 in / 50.8x20.3x47 cm

Side View

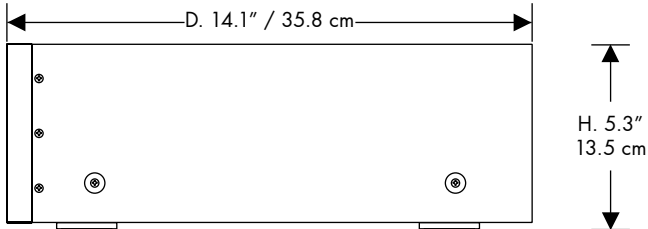

Front View

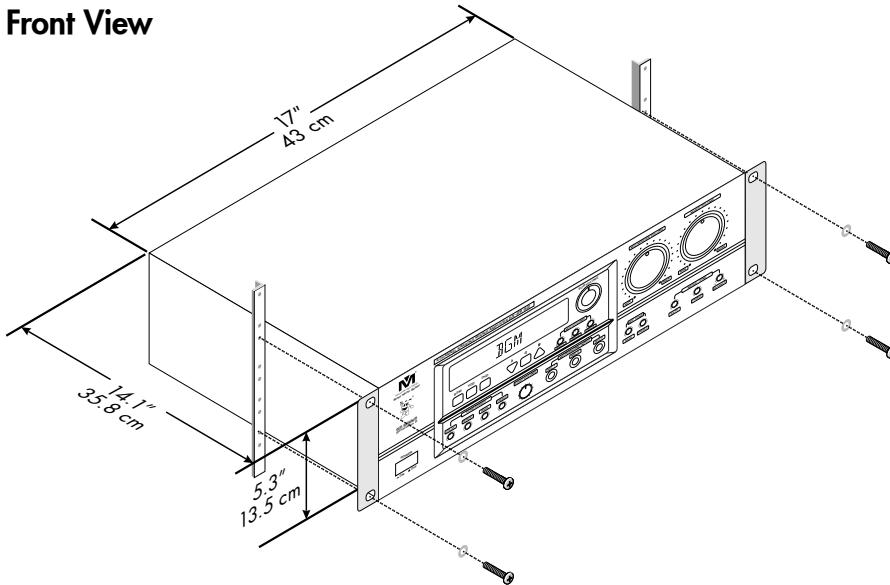

SPECIFICATIONS

POWER OUTPUT	PEAK 500W, RMS 260W (8 ohm); RMS 300W (4 ohm)	
THD	≤0.7%	
FREQUENCY RESPONSE	20Hz~20KHz +/-1dB	
TONE ELECTRICAL CIRCUIT	MUSIC PART BASS Control: 100Hz ± 10dB TREBLE Control: 10kHz ± 10dB	MIC PART BASS Control: +6dB/-16dB TREBLE Control: +6dB/-16dB
INPUT SENSITIVITY/IMPEDANCE	220 mV	
EFFECT	ECHO	
MUSIC INPUT HF/LF	HF (INCREASE/ATTENUATE): ±8 dB LF (INCREASE/ATTENUATE): ±8 dB	
MUSIC INPUT S/N RATIO	≥80 dB	
POWER CONSUMPTION	AC 110V/~60Hz (North America Market) AC 220V/~50Hz (Asia or Europe Market)	

PORTABLE SYSTEM

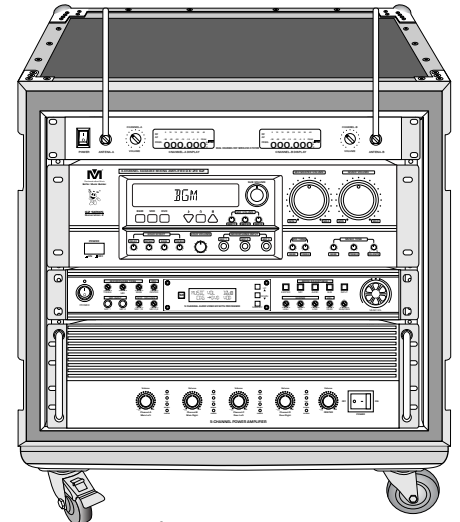

OPTIONAL 19" RACK MOUNT KIT

The Rack Mount kit is optional. Please make sure to get the right kit size, then put the amplifier into the rack. The rack is used to protect the amplifier. With such portable equipment, it is possible to have party at home anytime or use it for Karaoke rental business.

The Bracket/Handler (optional) is used to hold your audio/video equipment firmly in place, but not for transportation. If you need to transport the equipment, we recommend you using the heavy duty clamping rack shelf (optional) as illustrated in figure. You should place the heavy duty clamping rack shelf into the portable case. This would protect your equipment. There are different sizes of the heavy duty clamping rack shelves to suit your specific needs. Please note that the bracket/handler, rack shelf and case are not included in the package. They are optional items and sold separately.

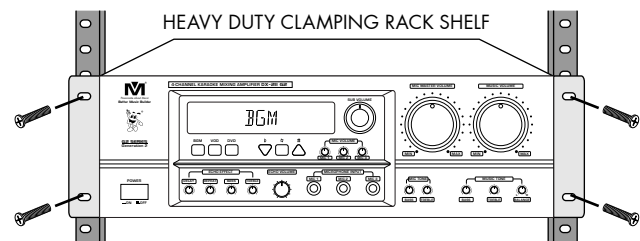
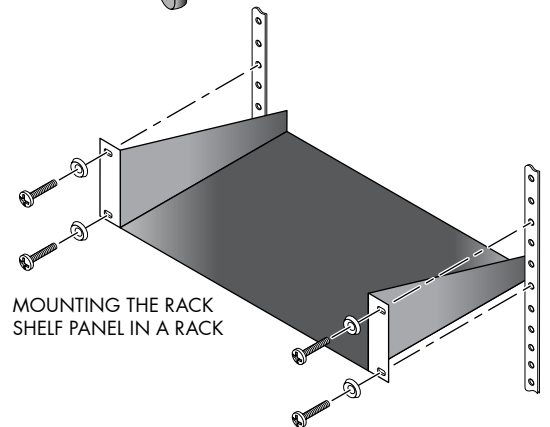



TROUBLESHOOTING

1. MUSIC VOLUME IS TOO LOW

CAUSE: the music volume limiter is set too low.

REMEDY: adjust to a higher "Max Music Volume."

2. MICROPHONE VOLUME IS TOO LOW

CAUSE: the mic master volume limiter is set too low.

REMEDY: adjust to a higher "Max Mic Master Volume."

3. NO SOUND FROM SUBWOOFER

CAUSE: SUB is turn off.

REMEDY:

- Turn on the SUB: press SUB button two times.
- Be sure to adjust the SUB volume to a high enough value.
- Check to make sure subwoofer is turned on.
- Select SUB for all inputs: press SUB button three times.

4. NO SOUND FROM MICROPHONE

REMEDY:

- Be sure the microphone is turned on.
- Microphone cable is connected properly.
- Check the microphone volume

5. MACHINE HAS NO POWER

REMEDY: check to see if the power cable is well connected and that the power switch on the front panel is turned on.

6. BAD AUDIO OR MICROPHONE SOUNDS

REMEDY:

- Check the source of your audio (CD, DVD) to see if it's scratched.
- Check your audio cables or microphone cables.
- Use a better audio cable or 3pin XLR mic cable.

7. THERE IS NO PICTURE

REMEDY:

- Check to see if your video sources are selected accordingly.
- Check to see if you plugged in the video cables.
- Check your TV or display monitor.

8. VIDEO IS FLICKERING

REMEDY:

- Check to see if the AV cable is damaged or not.
- Use a better AV cable.
- We recommend connecting videos to the TV or monitor directly for best results.

9. VIDEO SIGNAL OUT RECOMMENDATIONS

REMEDY: if you have more than 2 RCA output to the display, we recommend you use a signal amplifier. The signal amplifier will stabilize your video quality. If you have a HDTV (Plasma, or LCD) video we recommend you directly connect your source to the video display.

10. POWER CAN NOT BE TURNED ON

REMEDY:

- Check to see if your unit is plugged in properly.
- Check your power cable.

11. PROTECTION FOR AUDIO/VIDEO EQUIPMENT

Before you hook up or disconnect any audio/video equipment, you must turn off the power for all equipment. Otherwise, it may cause black spots to appear on the LCD or Plasma TV screen.

12. NO VIDEO SIGNAL OR VIDEO SIGNAL IS UNSTABLE

DX-211 G2 operates in multi-video formats. It is possible that your DVD player is in PAL video format. NTSC video format is used in North America. Therefore, you must set the video format to NTSC in the remote controller of the DVD player.

DVD PLAYER VIDEO SETTING		
TV Display	PS	Normal/PS Normal/LB Wide
TV Type	NTSC	PAL Multi NTSC (Good for Northern America)
TV Output	SVideo	YUV (High Difinition Video) SVideo

13. REMOTE CONTROL IS NOT WORKING

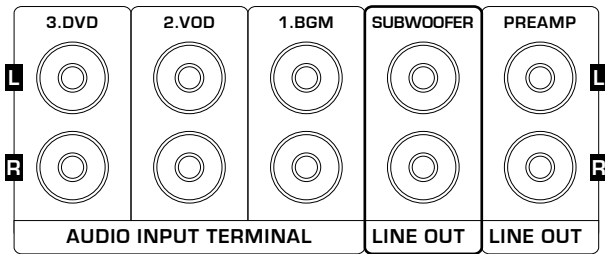

REMEDY: When connecting multiple audio sources the priority source will automatically be selected. (The sources are listed in the following order BGM [1], VOD [2] & DVD [3]. BGM is the priority source.)

- **USING BGM, VOD, DVD, AUX:** When using the BGM input, you cannot change to VOD, DVD or AUX unless you pause the incoming audio from BGM, then you can select between VOD, DVD or AUX (once you begin to play audio from BGM, the source will automatically change back to BGM).

- **USING VOD, DVD:** When using VOD and DVD only, you are free to select between the two sources. Pausing one source will switch the audio to the next source.

14. AUDIO FEEDBACK

REMEDY:

- Turn down the dB on the equalizer especially 1K, 2.5K, 5K, and 10K Hz.
- Turn off the Mix Excite.

15. AMPLIFIER SHUT DOWN/INTERFERENCE NOISE

CAUSE: The amplifier powered on but there is no music output.

REMEDY: Make sure that the AC-power supply is connected to the correct voltage level.

16. NOISE AND DISTORTION

When humming noise or displeasing sound appears, you can replace the supplied power cord with an AC power cord with a magnetic device as shown in the figure below.

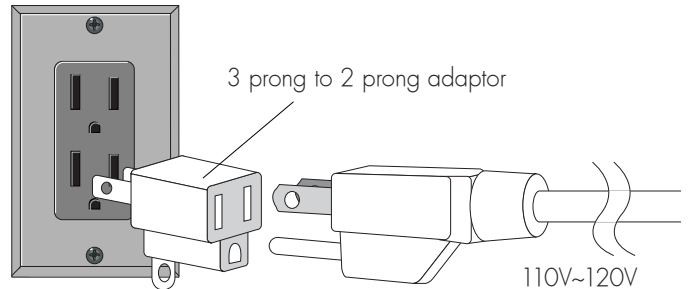

FIGURE 1

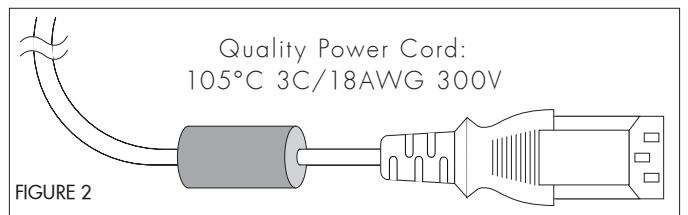
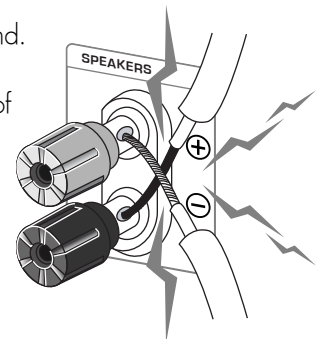

FIGURE 2

NOTE Radio signals from satellite TVs, HD TVs and cable TV receivers. May cause interference that in both audio and video equipment. The power cord as shown in figure 2 may help eliminate the humming sound and enhance TV picture quality.

17. SOUND PROBLEM: No sound.

REMEDY: Positive and negative of speaker wire are touching each other at the terminals. We recommend using double banana plugs.





WARRANTY

ONE-YEAR LIMITED WARRANTY FOR HOME USE EQUIPMENT

Our one-year warranty covers both parts and labors. The warranty becomes effective from the date of your purchase for one year.

Our warranty only covers defects due to product defectiveness with free of defects in materials or workmanship. However, our warranty does not cover defects due to normal wears, damage in transit, improper use, abuse or failure to follow the proper instructions for maintenance. This warranty is void in the event of unauthorized repairs, alternations, modifications and removing of the product label.

Please also note that our warranty does not cover any shipping cost for the return of defective products to us for inspection, repair and maintenance. Our warranty for Better Music Builder products can only be executed in North America.

90-DAY LIMITED WARRANTY FOR PUBLIC AND COMMERCIAL USE EQUIPMENT

Our 90-day warranty applies to speakers, amplifiers, mixers and microphones for both public and commercial use such as restaurant, coffee shop, KTV nightclub, church and school, etc. It covers both parts and labors. The warranty becomes effective from the date of your purchase for 90 days.

Our warranty only covers defects due to product defectiveness with free of defects in materials or workmanship. However, our warranty does not cover defects due to normal wears, damage in transit, improper use, abuse or failure to follow the proper instructions for maintenance. This warranty is void in the event of unauthorized repairs, alternations, modifications and removing of the product label.

Please also note that our warranty does not cover any shipping cost for the return of defective products to us for inspection, repair and maintenance. Our warranty for Better Music Builder products can only be executed in North America.

ADDITIONAL NOTES:

1. Limited warranty for home use equipment is only valid in North America.
2. Limited warranty is valid only if you purchase our products from our authorized dealers (including both regular retailers and online retailers) in North America. If you choose to purchase our products from an authorized dealer, we will not provide any limited product warranty for you. To protect your limited product warranty, please purchase our products from one of our authorized dealers in North America near you.
3. Limited warranty is automatically void if the yellow label stating "No Warranty After Opening" is removed from the product.

TO REGISTER YOUR WARRANTY

Please fill out the warranty card that came with your unit, download or submit online warranty form. However, we need the invoice for your purchase in order to process this warranty. You may also register your warranty online. Please visit our website at www.bettermusicbuilder.com.



AGENCY REGULATORY NOTICES

FEDERAL COMMUNICATIONS COMMISSION NOTICE

These limits are designed to provide reasonable protection against harmful interference in a residential installation. This equipment generates, uses, and can radiate radio frequency energy and, if not installed and used in accordance with the instructions, may cause harmful interference to radio communications. However, there is no guarantee that interference will not occur in a particular installation. If this equipment does cause harmful interference to radio or television reception, which can be determined by turning the equipment off and on, the user is encouraged to try to correct the interference by one or more of the following measures:

- Reorient or relocate the receiving antenna.
- Increase the separation between the equipment and the receiver.
- Connect the equipment into an outlet on a circuit different from that to which the receiver is connected.
- Consult the dealer or an experienced radio or television technician for help.

Modifications

The FCC requires the user to be notified that any changes or modifications made to this device that are not approved may void the user's authority to operate the equipment.

Cables

Connections to this device must be made with shielded cables with metallic RFI/EMI connector hoods to maintain compliance with FCC rules and regulations.

MATERIALS DISPOSAL

Disposal of this material can be regulated because of environmental considerations. For disposal or recycling information, contact your local authorities or the Electronic Industries Alliance (EIA) (<http://www.eiae.org>).

DISPOSAL OF WASTE EQUIPMENT BY USERS IN PRIVATE HOUSEHOLDS IN THE EUROPEAN UNION

This symbol on the product or on its packaging indicates that this product must not be disposed of with your other household waste. Instead, it is your responsibility to dispose of your waste equipment by handing it over to a designated collection point for the recycling of waste electrical and electronic equipment. The separate collection and recycling of

your waste equipment at the time of disposal will help to conserve natural resources and ensure that it is recycled in a manner that protects human health and the environment. For more information about where you can drop off your waste equipment for recycling, please contact your local city office, your household waste disposal service or the shop where you purchased the product.

JAPANESE NOTICE

この装置は、情報処理装置等電波障害自主規制協議会（VCCI）の基準に基づくクラスB情報技術装置です。この装置は、家庭環境で使用することを目的としていますが、この装置がラジオやテレビジョン受信機に近接して使用されると、受信障害を引き起こすことがあります。
取扱説明書に従って正しい取り扱いをして下さい。

JAPANESE POWER CORD NOTICE

製品には、同梱された電源コードをお使い下さい。
同梱された電源コードは、他の製品では使用出来ません。

JAPANESE MATERIAL CONTENT DECLARATION

A Japanese regulatory requirement, defined by Specification JIS-C-0950, 2005, mandates that manufacturers provide Material Content Declarations for certain categories of electronic products offered for sale after July 1, 2006.

KOREAN NOTICE

8급 기기 (가정용 방송통신기기)	이 기기는 가정용(8급)으로 전자파적합등록을 한 기기로서 주로 가정에서 사용하는 것을 목적으로 하며, 모든 지역에서 사용할 수 있습니다.
-----------------------	--

RECYCLING PROGRAM

The terms and availability of these programs vary by geography because of differences in regulatory requirements and local customer demand.

因为在当地的监管要求和客户的需求，这些条件和程序的情况不同。



FINAL WORDS TO USER

The engineering team of Better Music Builder has many years of experience in audio equipment design. The team constantly develops new audio technologies, designs innovative audio and karaoke equipment to suit your specific needs and provides you great ideas for home entertainment.

Our engineering team also designs audio equipment for commercial use by restaurants, coffee shops, churches, and school auditoriums, etc. If the commercial area for audio equipment installation exceeds 2,000 square feet, we highly recommend hiring audio professionals to handle the installation in order to avoid risks in breaking the equipment with improper installation and safety protection purposes.

We also provide educational and technical information on audio equipment and technologies. For example, we provide free installation diagrams to make it easier to connect the system. In addition, to get best connections for the sharpest image and sound quality, we provide hot tips for choosing the high quality type of A/V cable connections. Free information on audio equipment and technologies available for download from our website, www.BetterMusicBuilder.com.

Please do not remove the "Yellow Label" on the rear of the machine; otherwise, the warranty will be void automatically. We design it to protect your own safety. If repair and maintenance service is needed, please contact us directly or hire a professional technician. To learn more about the technical aspects, visit our website www.BetterMusicBuilder.com and download the relevant information for review.



Before hooking up the system, turn off the power on all machines including audio/video equipment and TV. Otherwise, it may damage the equipment, especially on the HDTV in which a spot might appeared on the TV screen. After hooking up the system, double check the audio/video connections to ensure that they are connected correctly.

NOTE Sometimes, loose or poor quality cable would affect the microphone effects, picture quality, or even cause the machine to shut down suddenly.

Again, thank you for choosing Better Music Builder. We hope you can make the best use of the machine and enjoy it for years to come. If you have any questions regarding our product, please feel free to contact us at www.BetterMusicBuilder.com.



CONTACT INFORMATION

MAILING ADDRESS



BETTER MUSIC BUILDER
29300 Kohoutek Way #150
Union City, CA 94587
U.S.A.

TELEPHONE NUMBERS



USA Region
USA Toll Free: 1-800-318-2218
Sales & Marketing: 510-477-9955
Customer Service: 510-477-9955

FAX NUMBERS

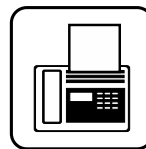

USA Region
Sales & Marketing: 510-477-9922
Customer Service: 510-477-9922

WORLD WIDE WEB



E-mail: sales@bettermusicbuilder.com
Website: www.bettermusicbuilder.com

MAINTENANCE

With proper maintenance and regular service, it would maintain the machine quality and prolong its life. We recommend you to print the following information clearly for future reference on maintenance and warranty.

MODEL# _____ INVOICE # _____

DATE PURCHASED (MM/DD/YYYY) _____

DEALER NAME _____

CITY _____ ST./PROV. _____ ZIP/P.C. _____

DEALER WEBSITE <http://www.> _____

DEALER PHONE # _____

DEALER E-MAIL _____

Better Music Builder®.com



Passionate about Music

Thank you for purchasing this unit. To make full and effective use of this unit, please read this Owner's Manual carefully before operating it. Please retain this manual for future reference.

