



KP2015/KP2015-WH

15 Inch 2-Way Full Range Loudspeaker System

Professional Series

Key Features:

- ▶ 15" High efficiency woofer design
- ▶ 1" annular polymer diaphragm compression driver
- ▶ Enclosure constructed of 15 mm medium density fiberboard with rugged durable finish
- ▶ 70° x 100° coverage pattern for even and smooth response on and off axis
- ▶ Attractive cloth backed robust steel grille design
- ▶ Precision engineered crossover for optimal driver integration
- ▶ Rotatable JBL ENTERTAINMENT logo for both horizontal and vertical applications
- ▶ Two enclosure color option: Black (KP2015) or White (KP2015-WH)



Applications:

- ▶ Karaoke sound reinforcement
- ▶ Club live sound reinforcement
- ▶ High-performance satellite speaker for use with subwoofers

The KP2015 is a compact and premium high-output full-range loudspeaker.

The KP2015 uses a 380 mm (15 in) humidity protection woofer with optimal demodulating/cooling aluminium ring inside, which is high power, low distortion and low power compression, and a 2414H-C 25 mm (1 in) annular polymer diaphragm compression driver for 350 watts power capacity. 70° x 100° coverage pattern provides smooth, even coverage whether used in the vertical or horizontal orientation. The high-order passive network minimizes band overlap.

The enclosure is constructed of 15 mm high quality medium density fiberboard and finished in a durable coating. The trapezoid enclosure is fitted with a Neutrik NL4MP connector for the connection with other device, nine M10 threaded suspension points and four M10 screws for Karaoke bracket mounting. It utilizes a 1.2 mm SPCC protective screen backed steel grille to provide driver protection with a very professional appearance.

Specifications:

System:	
System Type:	15", 2-way, bass-reflex
Frequency Range (-10 dB) ¹ :	45 Hz - 20 KHz
Frequency Response (±3 dB) ¹ :	75 Hz - 17 KHz
System Sensitivity (1w @ 1m) ¹ :	98 dB
Nominal Impedance:	8 ohms
Maximum SPL ² :	123 dB (129 dB peak)
Power Rating ³ : (Continuous/Program/Peak)	350 W/700 W/1400 W
Coverage Pattern:	70° x 100° (H x V)
Physical:	
Dimensions (H x W x D):	689 mm x 433 mm x 450 mm 27.12 in x 17.04 in x 17.72 in
Net Weight:	24.0 kg (52.9 lbs)
LF Driver:	1 x 15" woofer
HF Driver:	1 x 2414H-C
Input Connector:	1 x Neutrik® Speakon® NL4MP
Enclosure Construction:	Trapezoid, 15 mm, MDF
Enclosure Color:	Black(KP2015)/White(KP2015-WH)

¹ Full space (4π) conditions

² Calculated maximum SPL based on rated power handling

³ IEC standard, pink noise with 6 dB crest factor for 2 hours

JBL continually engages in research related to product improvement. Some materials, production methods and design refinements are introduced into existing products without notice as a routine expression of that philosophy. For this reason, any current JBL product may differ in some respect from its published description, but will always equal or exceed the original design specifications unless otherwise stated.

▶ KP2015/KP2015-WH 15 Inch 2-Way Full Range Loudspeaker System

Frequency Response:

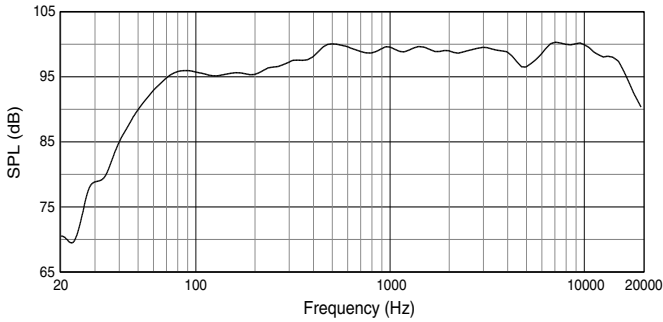

Beamwidth:

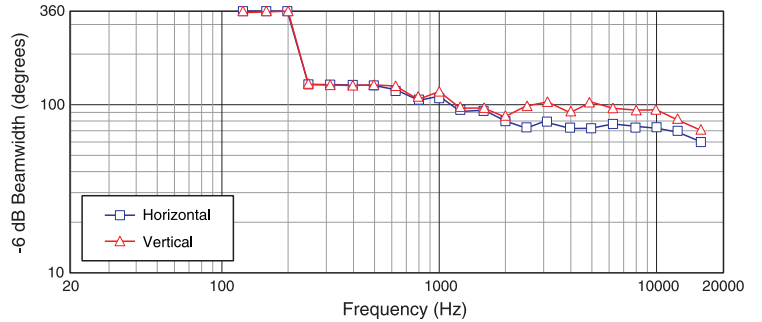

Dimensions:

Dimensions in mm (inch)

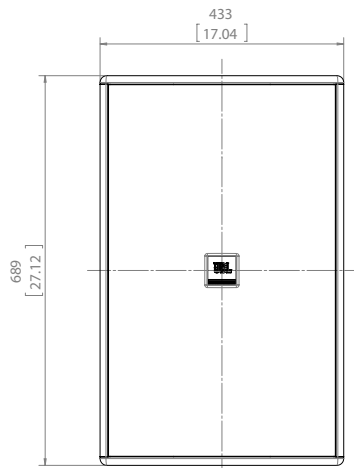
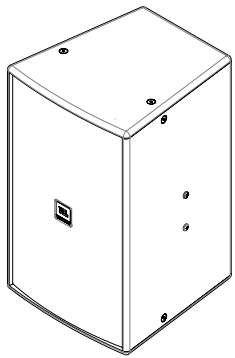

FRONT

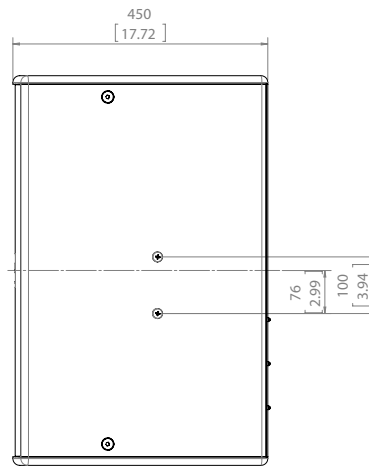

SIDES

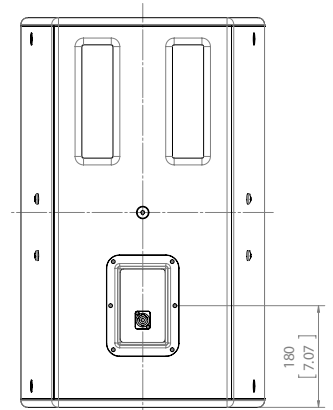

REAR

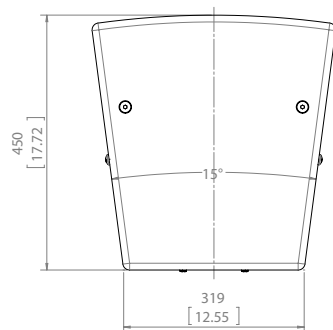
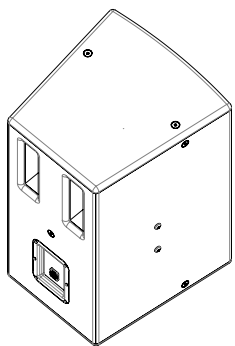

TOP



JBL Professional
8500 Balboa Boulevard, P.O. Box 2200
Northridge, California 91329 U.S.A.

© Copyright 2014 JBL Professional
www.jblpro.com

SSKP2015
SSKP2015-WH
SZ
05/15